

Przekroje poprzeczne wzdłuż profilu A-B

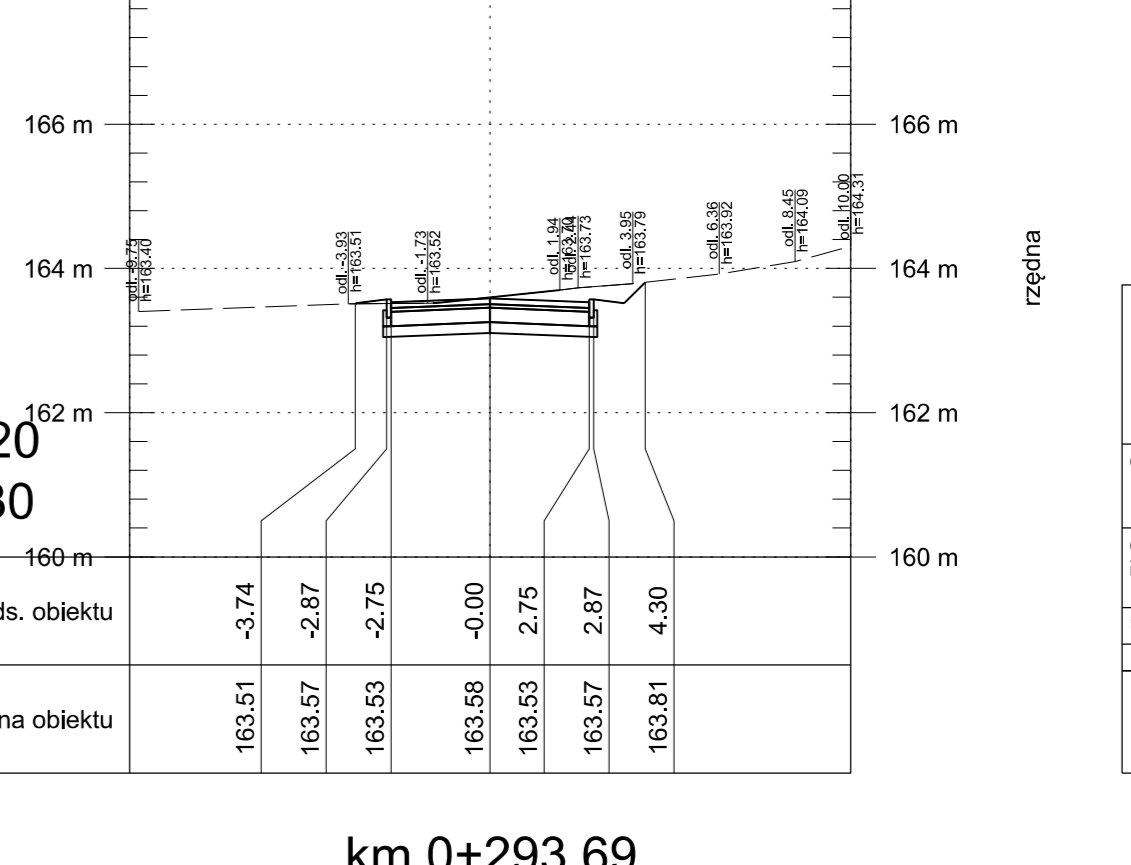
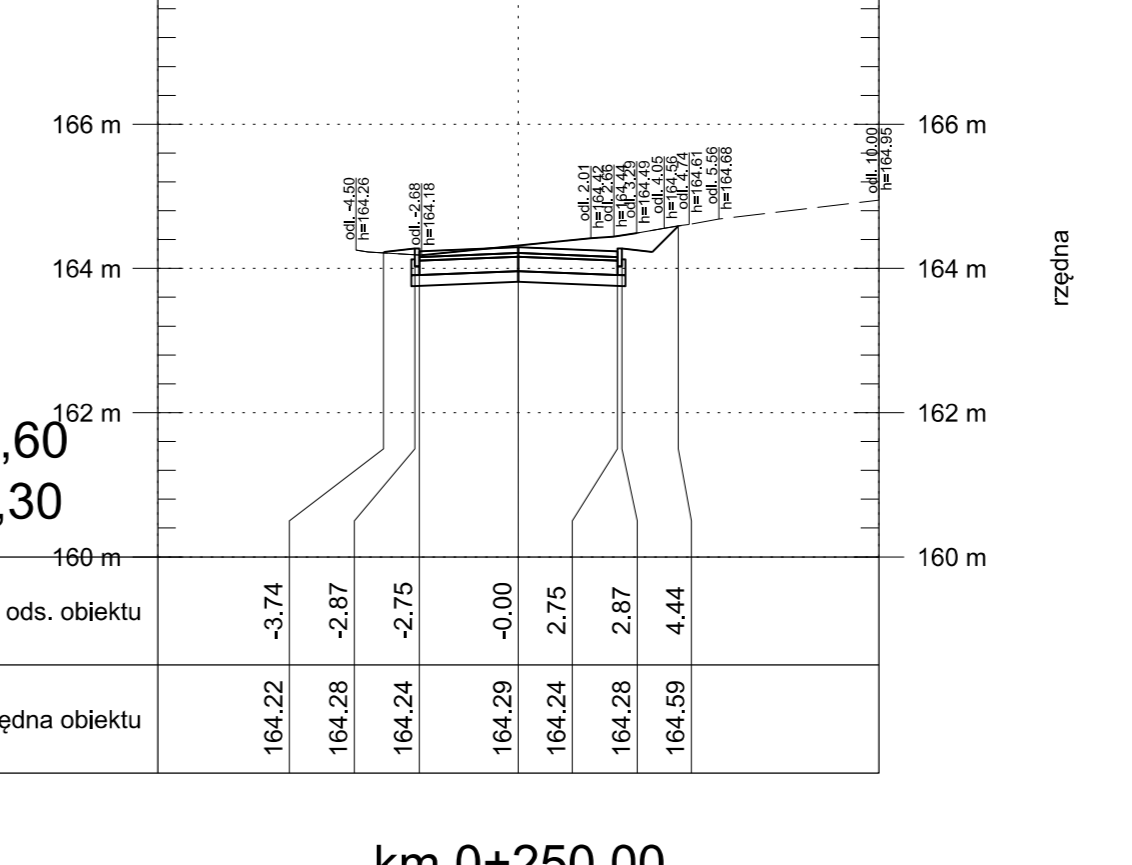
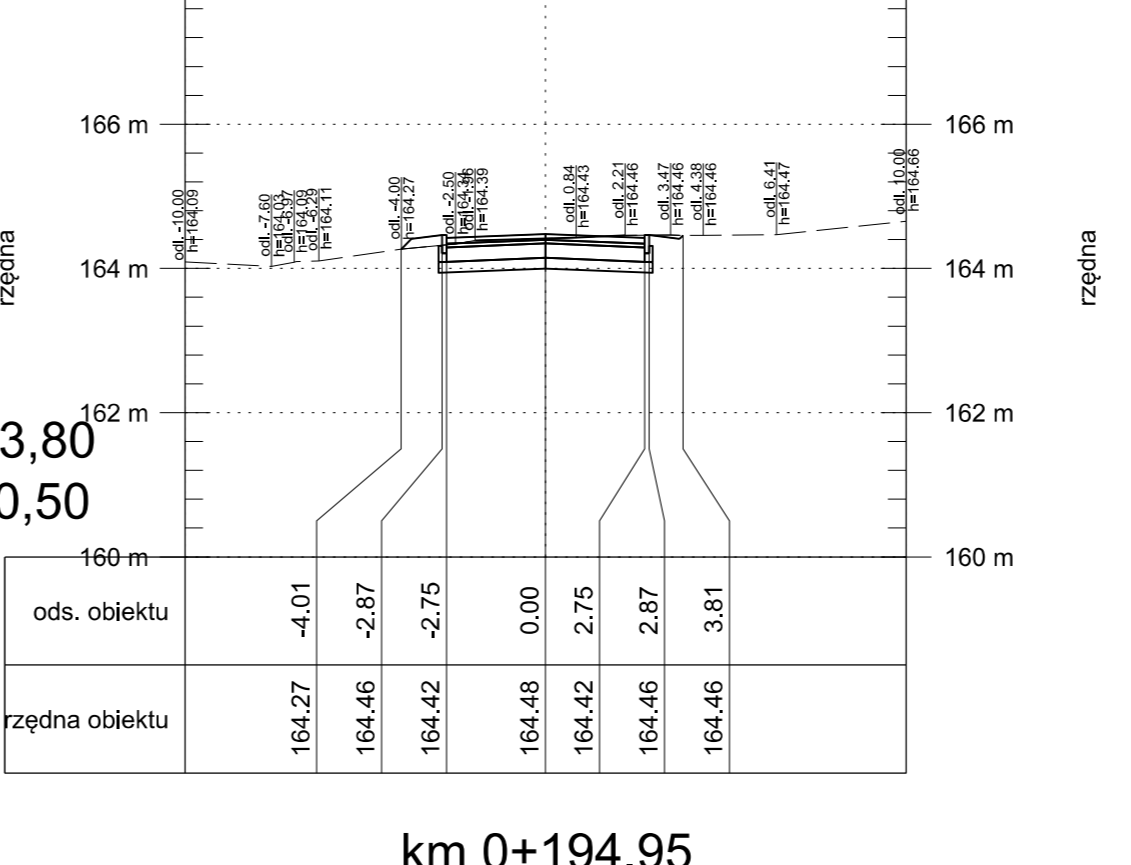
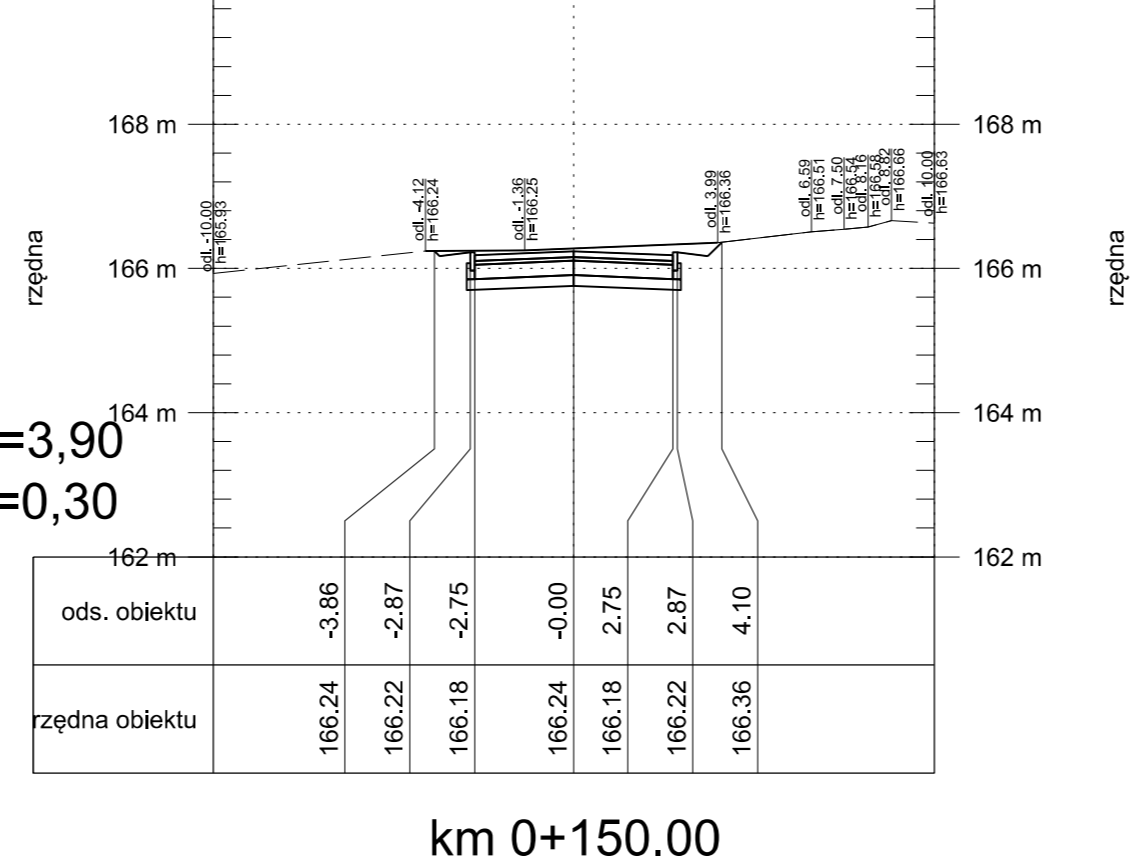
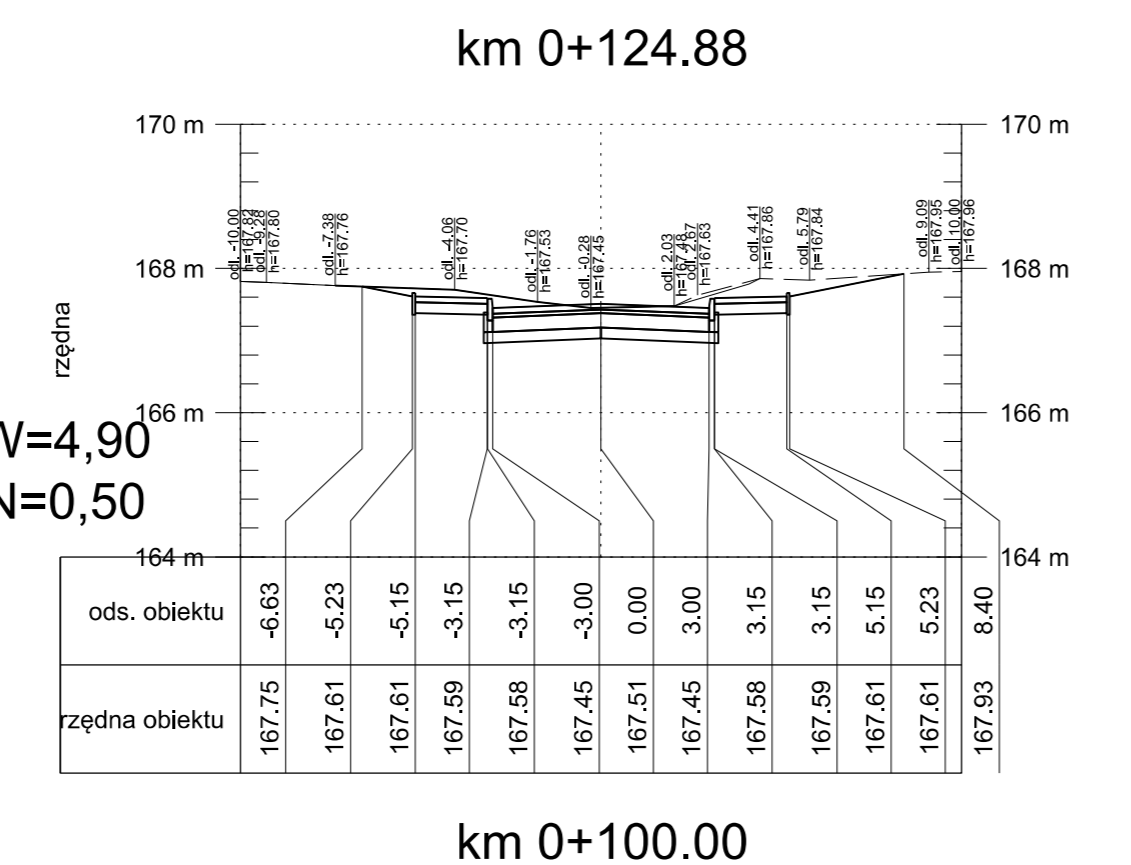
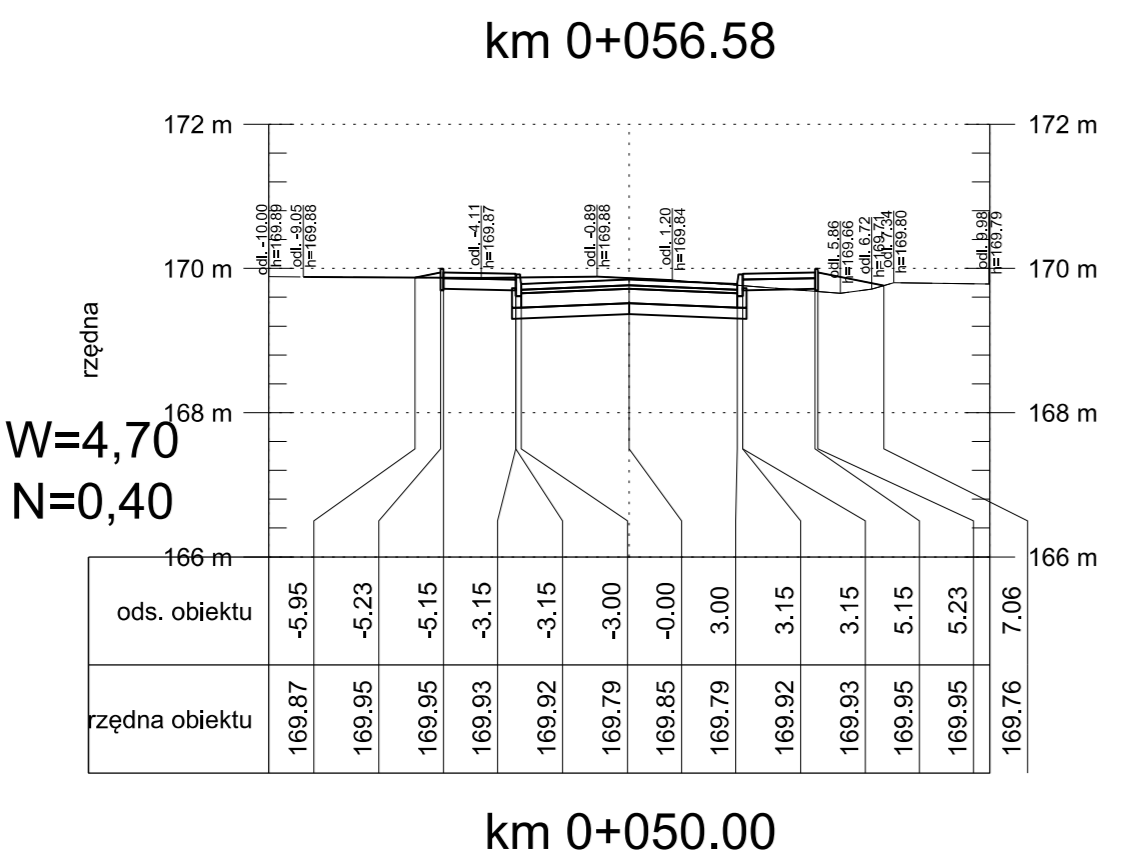
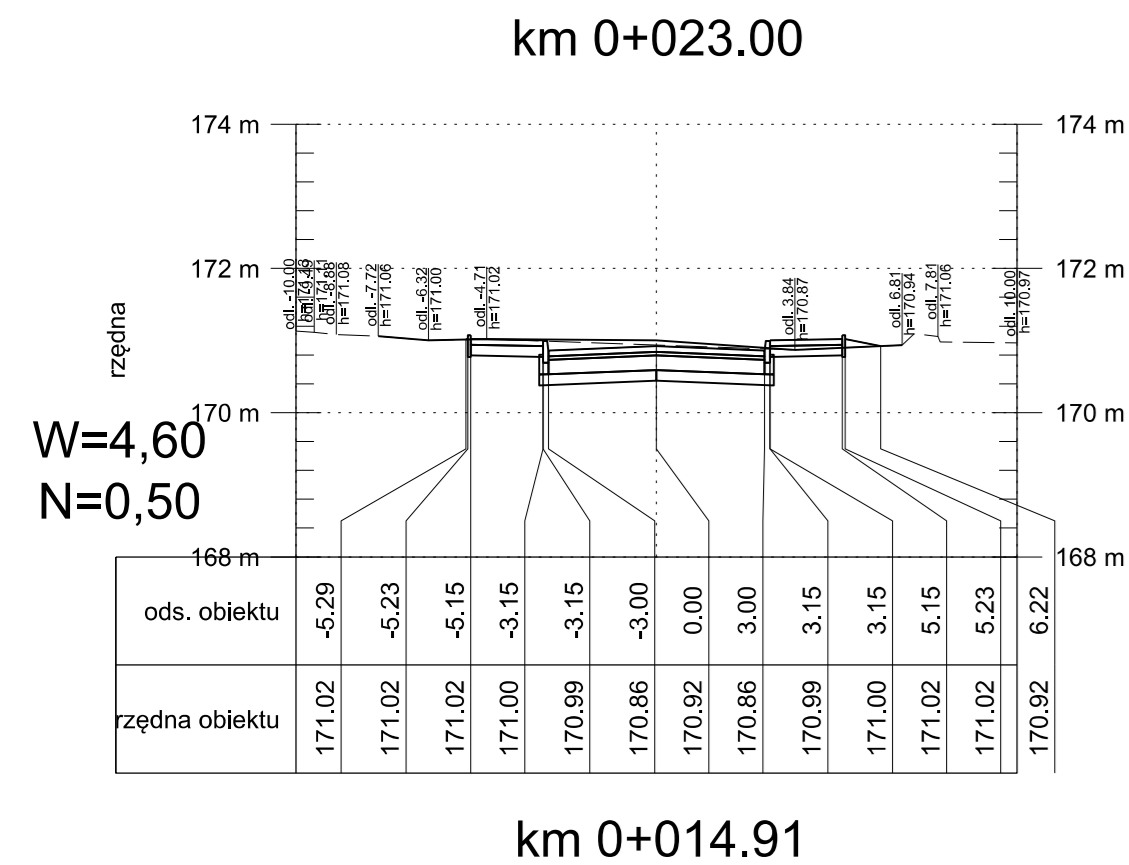
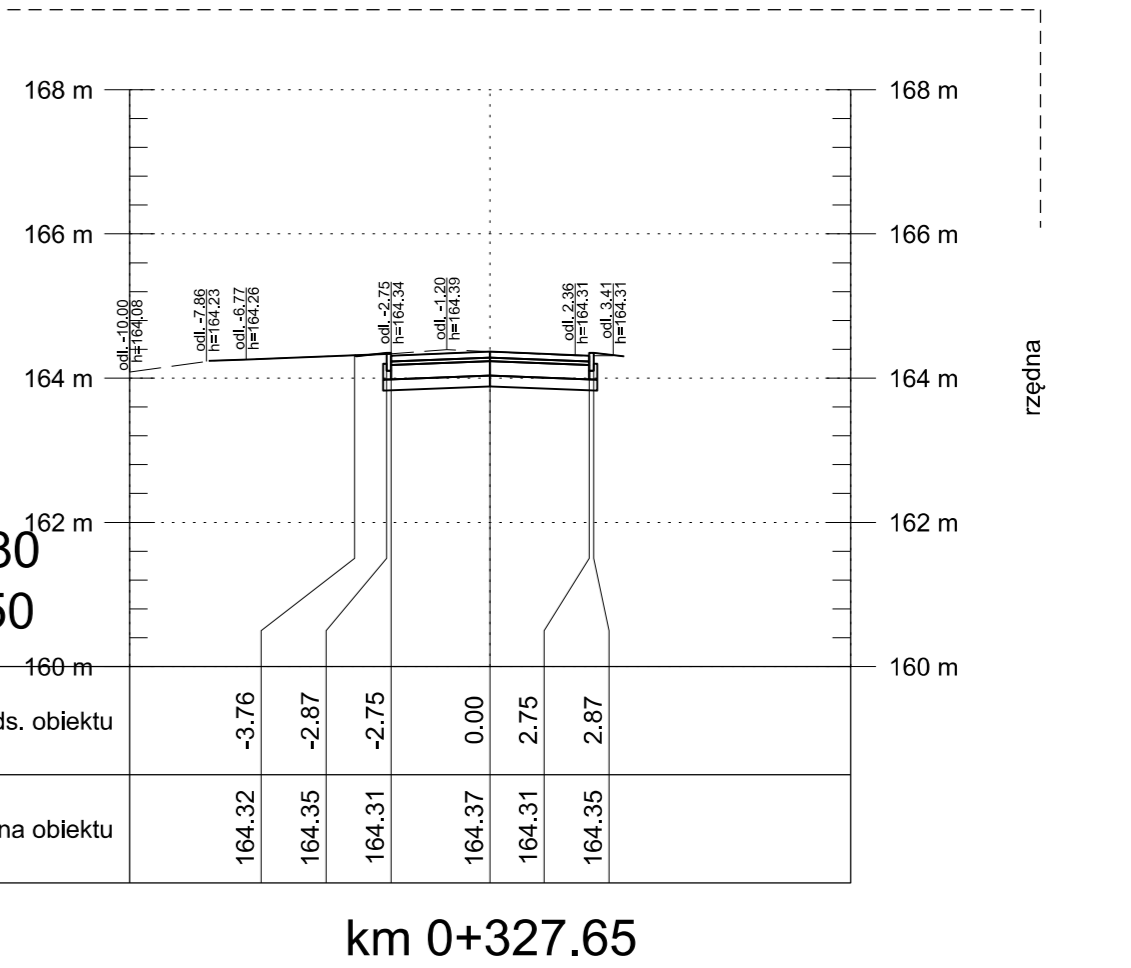
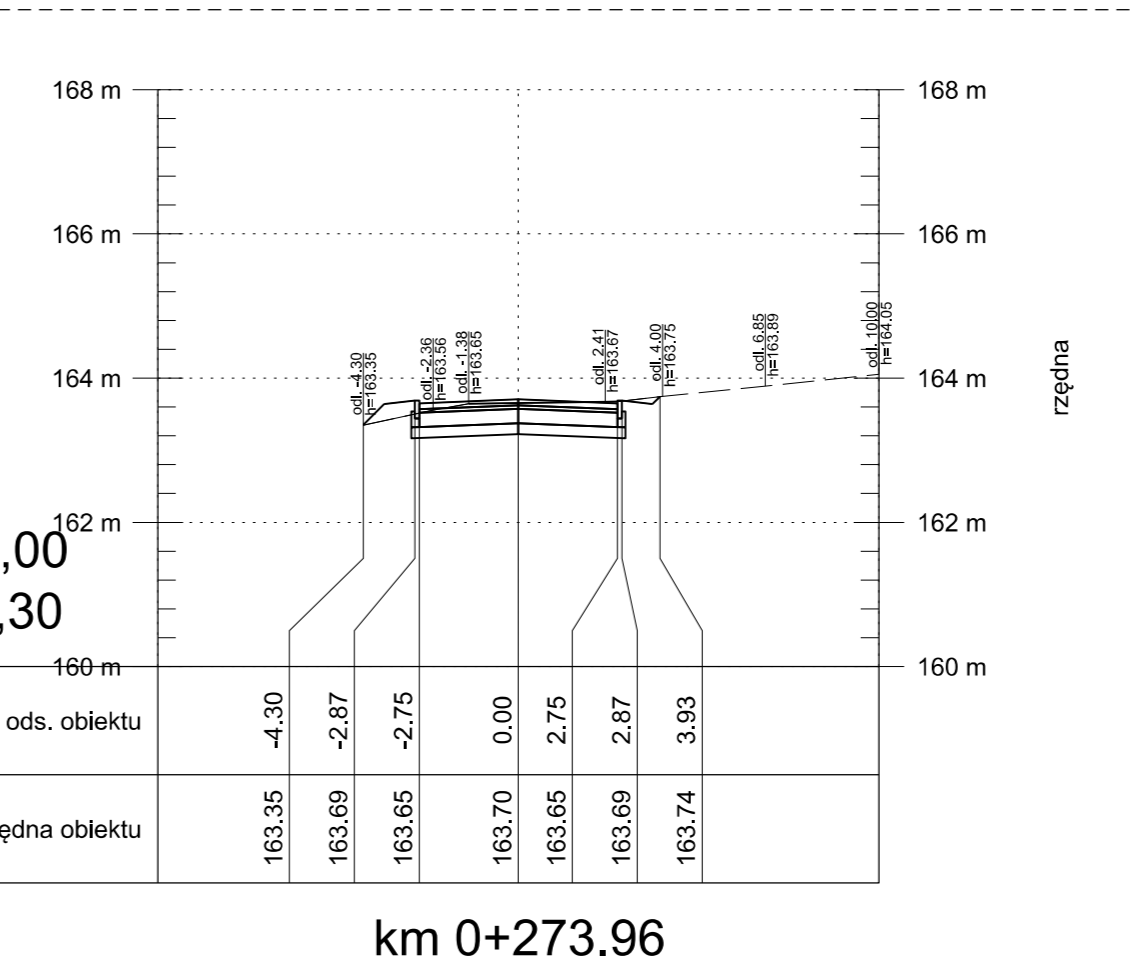
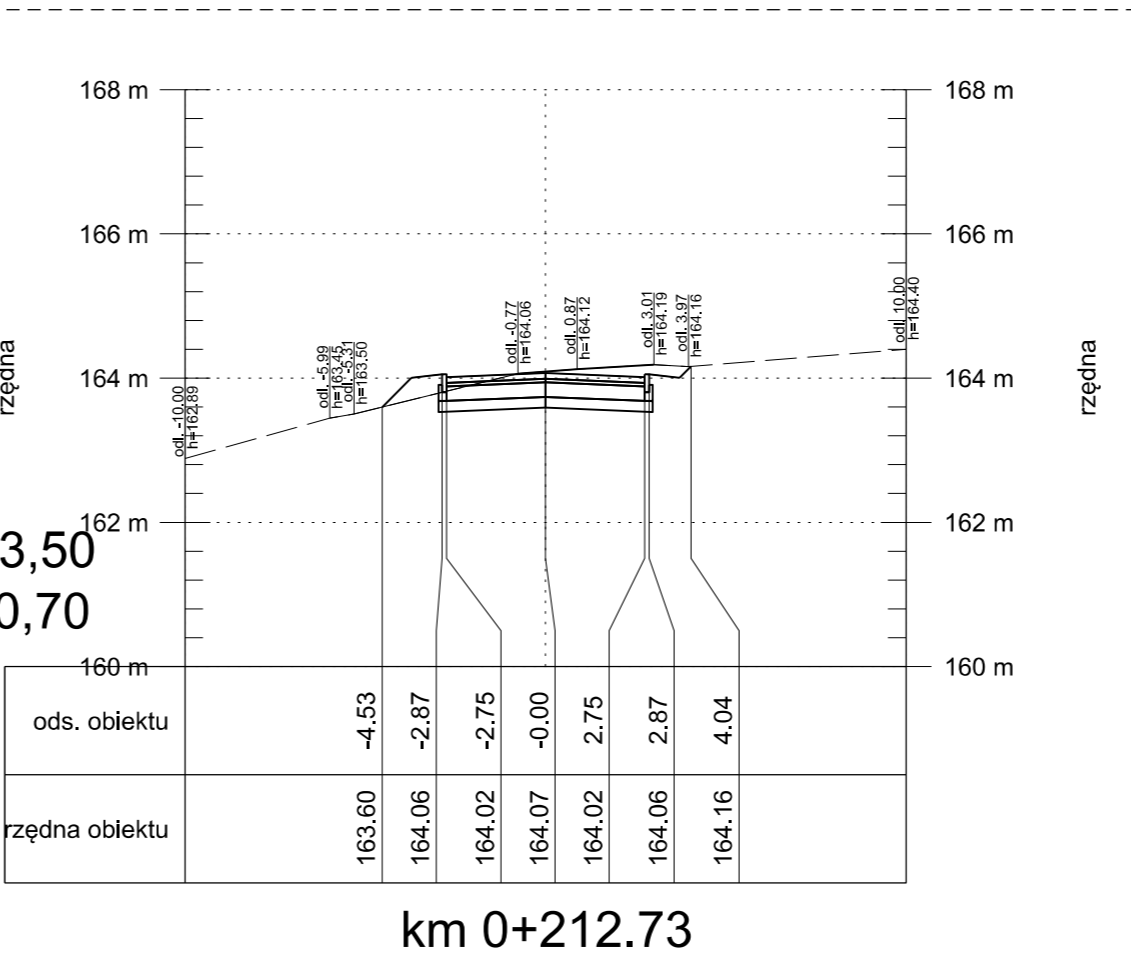
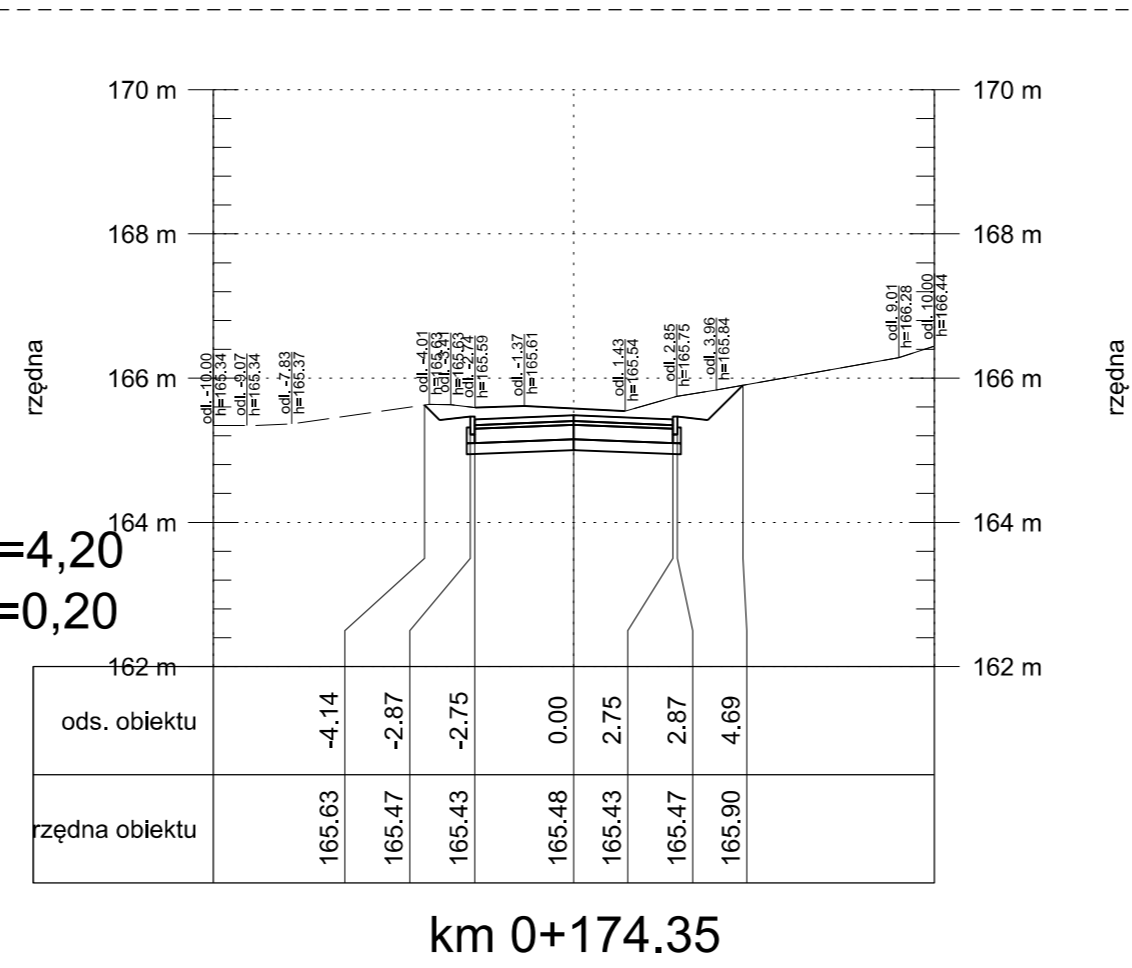
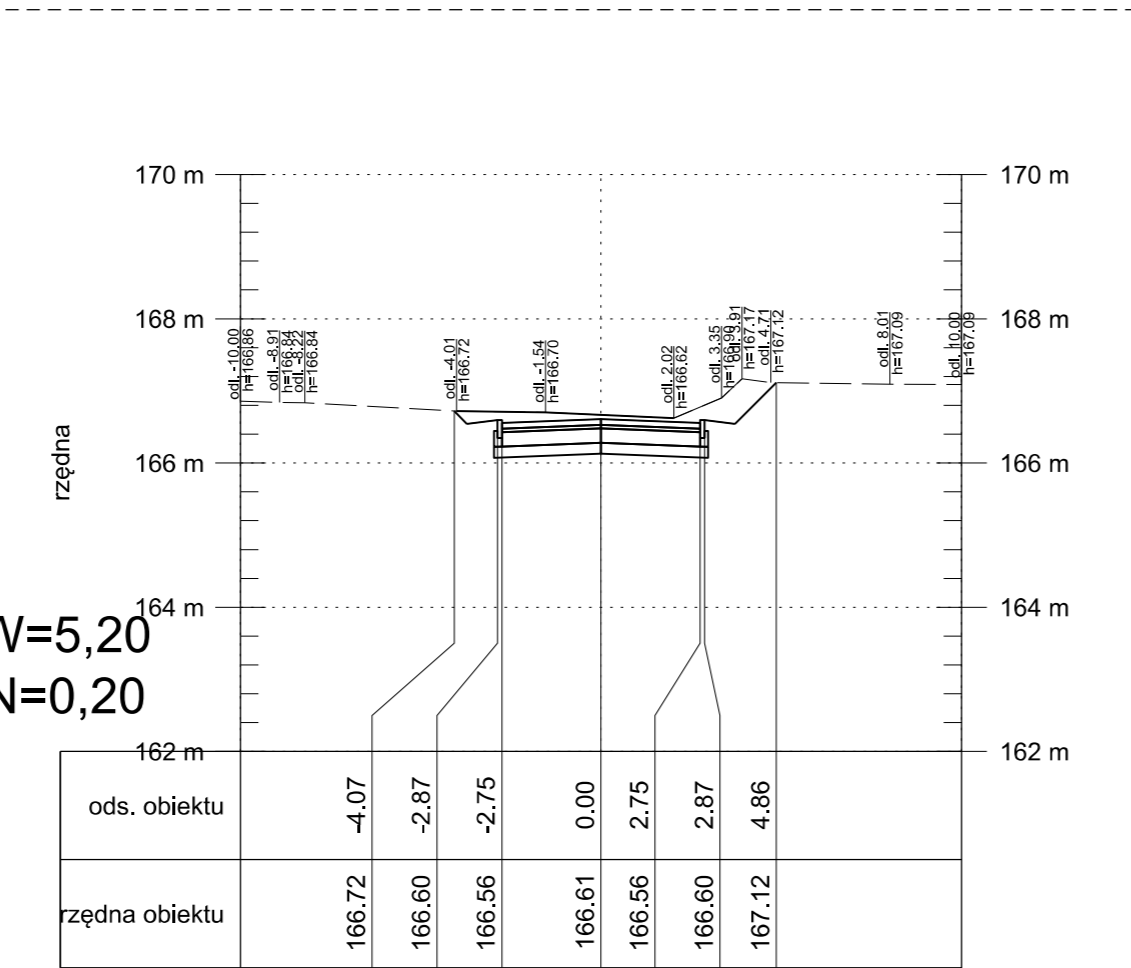
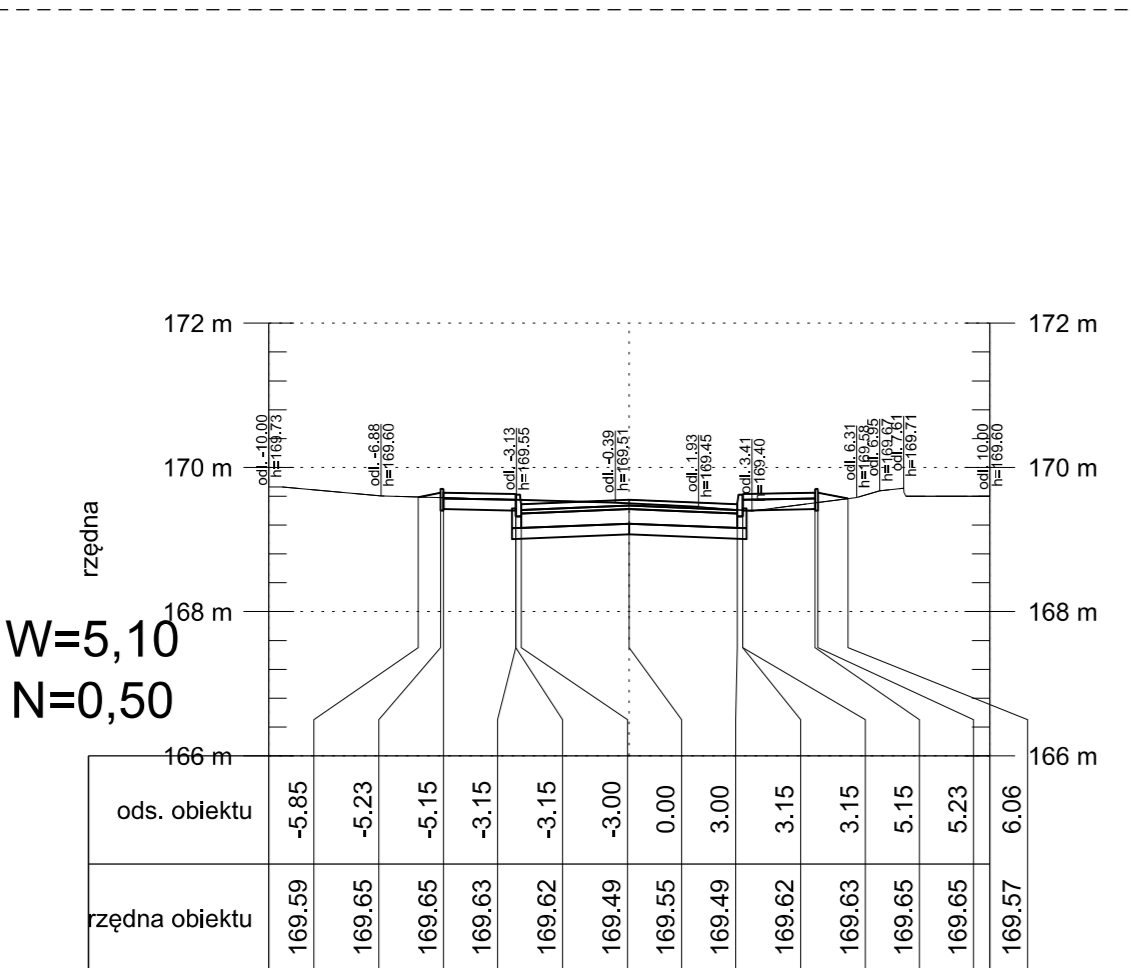
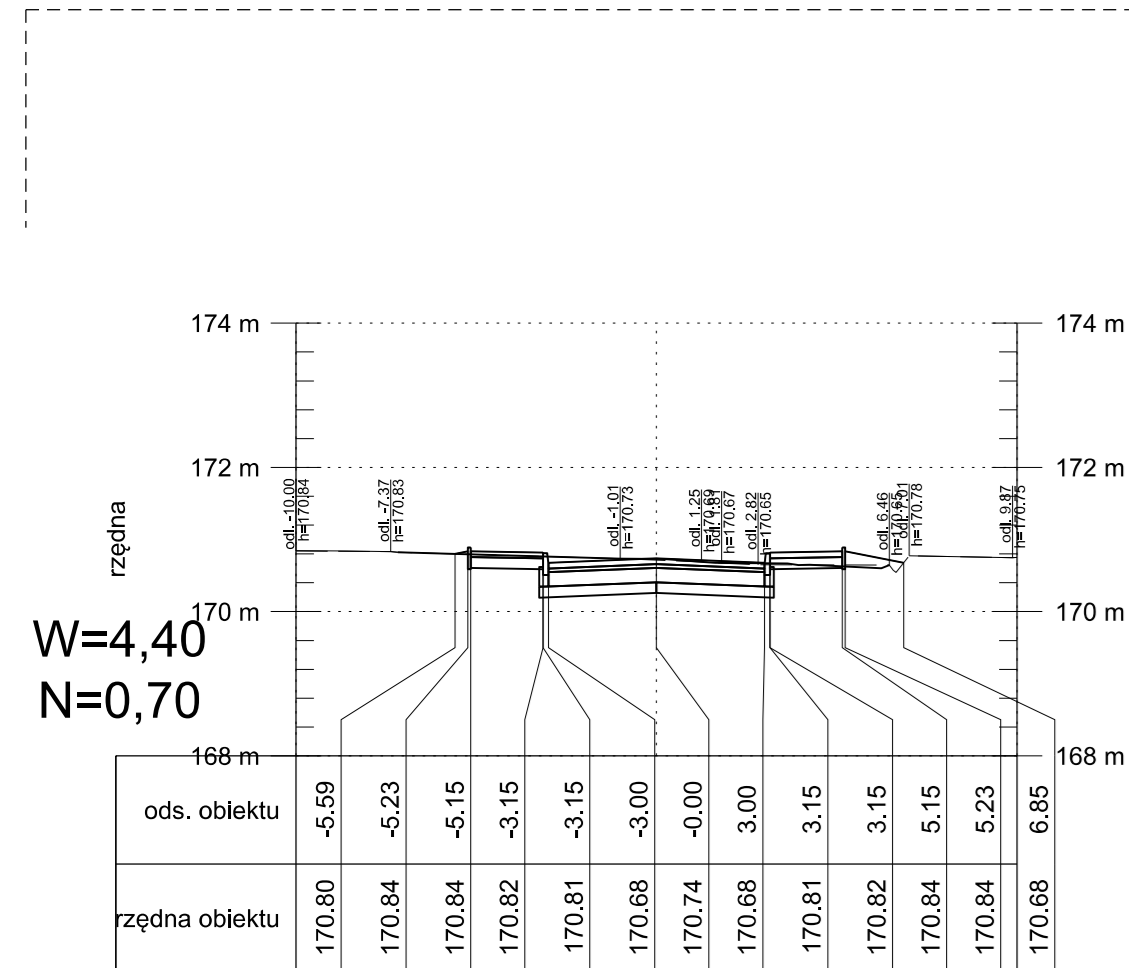

| | | | | |
|----------------------------|---|---|-----------|---------------------------|
| | | PROJEKTOWANIE ARCHITEKTONICZNE I BUDOWLANE AP Studio 7 mgr inż. arch. Piotr Adamowski 77-300 Człuchów ul. Traugutta 13 | | nr rys. 5.1 skala 1:50 |
| obiekt adres inwestycji | Przebudowa nawierzchni drogowych wraz z przebudową kanalizacji deszczowej na ul. Jana Jeziorańskiego w Człuchowie | | | |
| temat rys. | PRZEKROJE POPRZECZNE | | | |
| wykonawca | branża | imię i nazwisko, uprawnienia | data | podpis |
| projektant | droga | mgr inż. DANIEL FOLEHR spr. bud. w specjalności drogowej do projektowania bez ograniczeń PDB/100/PROB/11 | luty 2015 | [signature] |